

miro bar stool 11-580

Hannes Wettstein, 2004
Sitz Formsperrholz, Holzgestell massiv
B34, T34, SH80

Hannes Wettstein, 2004
Assise en contreplaqué moulé, piètement en bois massif
L34, P34, HAss80.

Hannes Wettstein, 2004
Moulded plywood seat, solid wooden frame
W34, D34, SH80

Varianten / variantes / variants



miro
11-560



miro
11-300



miro
11-400



miro
11-403



miro
11-303



miro
6-400



miro
6-400a



miro
6-403



miro
6-403a



miro
6-406



miro
6-406a

miro bar stool 11-580

Technische Angaben / specifications / specifications

Masse / mesure / measure

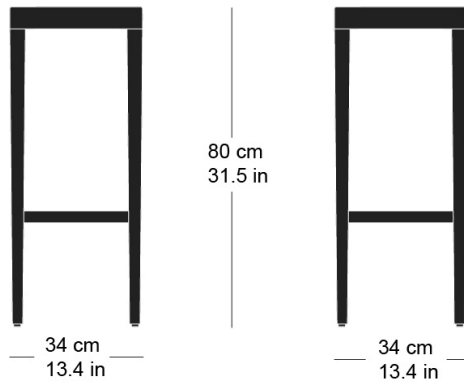

Gewicht / ponds / weight

4.2 kg 8.4 lb

miro bar stool 11-580

Holzarten / types de bois / types of wood

Belag / revêtement / surface



Natural beech HG 520
Buche natur HG 520
Hêtre naturel HG 520

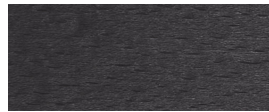

Anthracite beech HG 200
Buche anthrazit HG 200
Hêtre anthracite HG 200



White beech HG 330
Buche weiss HG 330
Hêtre blanc HG 330



Natural oak HG 530
Eiche natur HG 530
Chêne naturel HG 530



Ebony beech HG 100
Buche Ebony HG 100
Hêtre teinté ebony HG 100



Light grey beech HG 340
Buche hellgrau HG 340
Hêtre clair gris HG 340



Stained smoked oak HG 535
Eiche gebeizt Räuchereiche HG 535
Chêne teinté com chêne fumée HG 535

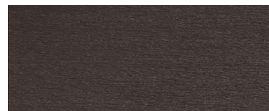

Wenge beech HG 110
Buche Wenge HG 110
Hêtre teinté wenge HG 110

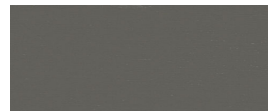

Grey beech HG 350
Buche grau HG 350
Hêtre gris HG 350

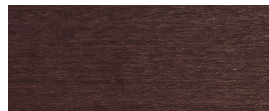

Mahogany beech HG 130
Buche Mahagoni HG 130
Hêtre teinté mahagoni HG 130

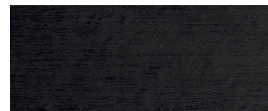

Black beech HG 203
Buche schwarz HG 203
Hêtre noir HG 203

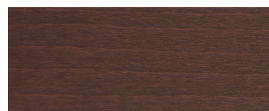

Maron beech HG 120
Buche Maron HG 120
Hêtre teinté maron HG 120

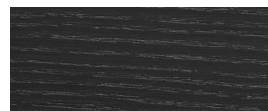

Black ash / oak HG 580
Esche / Eiche schwarz HG 580
Frêne / chêne noir HG 580

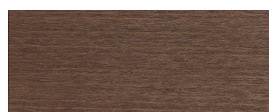

Maron beech HG 151
Buche Nuss HG 151
Hêtre teinté noyer HG 151

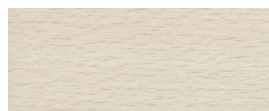

Whitewashed beech HG 172
Buche geweisst HG 172
Hêtre teinté blanc HG 172