

**lotus 1-060**

Conception d'usine, 1960

Sitz Formsperrholz, Rücken, Hinterfüsse und Sitzzarge  
massiv gebogen

B44, T52, H81, SH46

Conception d'usine, 1960

Assise en multiplis, pieds arrière, dossier et cadre du  
siège en bois massif cintré

L44, P52, H81, HAss46

Conception d'usine, 1960

Moulded plywood seat, back, rear legs and seat frame  
solid bentwood

W44, D52, H81, SH46

Varianten / variantes / variants



lotus  
1-063

Technische Angaben / specifications / specifications

Masse / mesure / measure

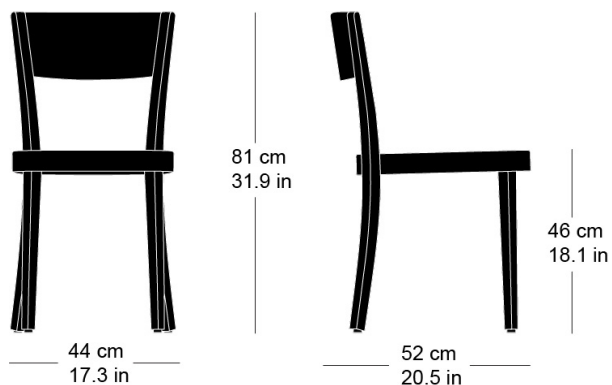

Gewicht / ponds / weight

4.3 kg 8.6 lb

**lotus 1-060**

## Holzarten / types de bois / types of wood



Hêtre naturel            HG 520  
Buche natur            HG 520  
Natural beech            HG 520



Hêtre anthracite        HG 200  
Buche anthrazit        HG 200  
Anthracite beech        HG 200



Hêtre blanc              HG 330  
Buche weiss            HG 330  
White beech            HG 330



Hêtre teinté ebony      HG 100  
Buche Ebony            HG 100  
Ebony beech            HG 100



Hêtre clair gris         HG 340  
Buche hellgrau        HG 340  
Light grey beech        HG 340

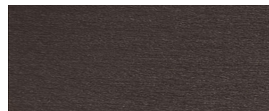

Hêtre teinté wenge     HG 110  
Buche Wenge            HG 110  
Wenge beech            HG 110

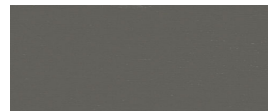

Hêtre gris                HG 350  
Buche grau             HG 350  
Grey beech              HG 350

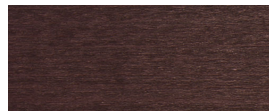

Hêtre teinté mahagoni    HG 130  
Buche Mahagoni        HG 130  
Mahogany beech        HG 130

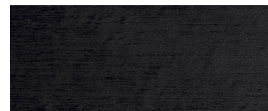

Hêtre noir                HG 203  
Buche schwarz         HG 203  
Black beech             HG 203

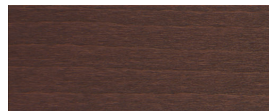

Hêtre teinté maron      HG 120  
Buche Maron            HG 120  
Maron beech            HG 120

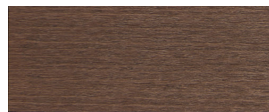

Hêtre teinté noyer        HG 151  
Buche Nuss              HG 151  
Nut beech                HG 151



Hêtre teinté blanc        HG 172  
Buche geweisst         HG 172  
Whitewashed beech     HG 172

## Belag / revêtement / surface