

miro tabouret de bar 11-580

Hannes Wettstein, 2004
Sitz Formsperrholz, Holzgestell massiv
B34, T34, SH80

Hannes Wettstein, 2004
Assise en contreplaqué moulé, piètement en bois massif
L34, P34, HAss80.

Hannes Wettstein, 2004
Moulded plywood seat, solid wooden frame
W34, D34, SH80

Varianten / variantes / variants



miro
11-560



miro
11-300



miro
11-400



miro
11-403



miro
11-303



miro
6-400



miro
6-400a



miro
6-403



miro
6-403a



miro
6-406



miro
6-406a

miro tabouret de bar 11-580

Technische Angaben / specifications / specifications

Masse / mesure / measure

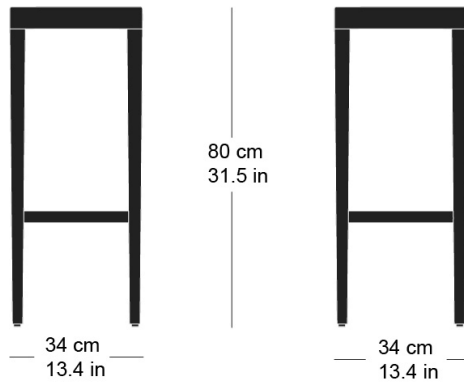

Gewicht / ponds / weight

4.2 kg 8.4 lb

miro tabouret de bar 11-580

Holzarten / types de bois / types of wood



Hêtre naturel	HG 520
Buche natur	HG 520
Natural beech	HG 520



Hêtre anthracite	HG 200
Buche anthrazit	HG 200
Anthracite beech	HG 200



Hêtre blanc	HG 330
Buche weiss	HG 330
White beech	HG 330



Chêne naturel	HG 530
Eiche natur	HG 530
Natural oak	HG 530



Hêtre teinté ebony	HG 100
Buche Ebony	HG 100
Ebony beech	HG 100

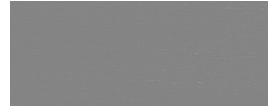

Hêtre clair gris	HG 340
Buche hellgrau	HG 340
Light grey beech	HG 340



Chêne teinté com chêne fumée	HG 535
Eiche gebeizt Räuchereiche	HG 535
Stained smoked oak	HG 535



Hêtre teinté wenge	HG 110
Buche Wenge	HG 110
Wenge beech	HG 110

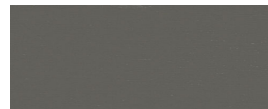

Hêtre gris	HG 350
Buche grau	HG 350
Grey beech	HG 350

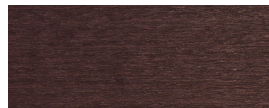

Hêtre teinté mahagoni	HG 130
Buche Mahagoni	HG 130
Mahogany beech	HG 130

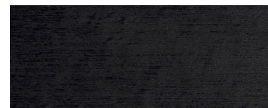

Hêtre noir	HG 203
Buche schwarz	HG 203
Black beech	HG 203

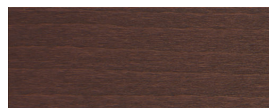

Hêtre teinté maron	HG 120
Buche Maron	HG 120
Maron beech	HG 120



Frêne / chêne noir	HG 580
Esche / Eiche schwarz	HG 580
Black ash / oak	HG 580

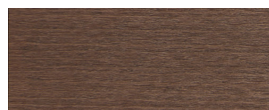

Hêtre teinté noyer	HG 151
Buche Nuss	HG 151
Maron beech	HG 151



Hêtre teinté blanc	HG 172
Buche geweisst	HG 172
Whitewashed beech	HG 172

Belag / revêtement / surface